



User Manual

CONTENT

1	HOW TO GET STARTED	3
2	SAFETY	3
3	INTENDED USE	4
4	SYSTEM REQUIREMENTS	5
5	DOWNLOAD OF VITALITY CHECK APP	5
6	PACKAGE CONTENT.....	5
7	PRODUCT DESCRIPTION	5
8	CHARGING OF BATTERY.....	7
9	TURNING THE DEVICE ON AND OFF.....	8
10	STEPS FOR PERFORMING A MEASUREMENT	9
	10.1 HOW TO CONNECT SCANNER WITH PHONE/TABLET	9
	10.2 PERFORMING MEASUREMENTS.....	12
11	MEASUREMENT BASICS.....	16
	PREPARATION BEFORE STARTING A MEASUREMENT	16
	PERFORMING MEASUREMENTS.....	16
	GENERAL ASPECTS INFLUENCING THE LEVEL OF MEASURED RESULTS	18
12	TROUBLESHOOTING.....	19
13	MAINTENANCE AND CLEANING	21
14	TECHNICAL SPECIFICATION	22
15	CERTIFICATIONS.....	23

1 How to get started

Please read the chapters of this manual in the ranked order carefully to correctly learn the handling of the device.

Before you can make a measurement, you must download the **VITALITY CHECK** app onto your phone or tablet (chapter 5) and you must charge the battery of your device (chapter 8). With a too low charging level, it is impossible to activate the device successfully.

The chapter 10 describes all necessary steps to do measurement. This includes preparations, for example how to connect the scanner with your phone/tablet. Before you conduct your first measurement please read the general instruction for a successful and precise measurement in chapter 11.

When the scanner is switched on, the light of the status indicators always informs you about the present status. If the indication is not identical with the descriptions in chapter 10, please go to the chapter 12 and check the information on the indicated status. As an automatic timeout will switch the scanner off in some situations, please memorize the configuration of lighting before searching in the chapter 12.

2 Safety

Read the safety instructions carefully before using the **VITALITY CHECK**. Retain these instructions for future use.

- Only use the scanner as described in the manual.
- Do not stare into the lights the device uses to measure. Keep your hand on the sensor during the complete measurement. Staring into the active lights can cause permanent or non-permanent damage to your eyes.
- Do not use the device near water or spill liquid of any kind on the device as this may cause a short circuit, a fire, or an electric shock which could cause serious injury, death, and property loss.
- Do not use or store the device in extreme temperatures (for example, do not leave it in a car that is in direct sunlight). The device might overheat and may present a burn and fire risk and cease to function.
- Do not drop the device or allow objects to fall on as this might cause a damage to the battery which might cause an explosion resulting in serious injury, death, and property loss.
- Do not dispose of the device in fire as this might cause an explosion resulting in serious injury, death, and property loss.
- Do not use the device in an aircraft as Federal Aviation Administration (FAA) and Federal Communications Commission (FCC) regulations prohibit the use of wireless devices while in the air. Turn off the device before boarding an aircraft. Using the device on an aircraft might affect aircraft instrumentation, communication, and performance; might disrupt the network; might otherwise be dangerous to the operation of the aircraft, its crew, and its passengers; and might be illegal.
- Do not disassemble the device.
- Most modern electronic equipment is shielded from radio frequency (RF) signals. However, certain electronic equipment might not be shielded against the RF signals from the device. Keep the device away from medical devices, including pacemakers and hearing aids, as they might malfunction and cause serious injury or death to the user and others.

- Do not use the device in health care facilities as there may be equipment that could be sensitive to external RF energy.
- The **VITALITY CHECK** contains an internal, Lithium-Ion battery which may only be replaced by an exact replacement available from the manufacturer. The replacement must be carried out by the manufacturer or a skilled electrician.
- Use only certified USB Type-C™ cables and suitable USB chargers to charge or power the product. Charging is carried out with 5V at approximately 500mA.
- Do not charge in a high moisture environment.

WARNING

DO NOT CHARGE THIS PRODUCT IN TEMPERATURE OUTSIDE AMBIENT OF (+5°C TO +40°C)

- Do not cover the device or charger while charging.

CAUTION

RISK OF EXPLOSION IF BATTERY IS REPLACED BY AN INCORRECT TYPE.

DISPOSE OF USED BATTERIES ACCORDING TO THE INSTRUCTIONS

- Disposal
Do not dispose of the device with unsorted waste. Improper disposal may be harmful to the environment and human health. Please refer to the local waste authority for information on return and collection systems in your area.
This device must not be disposed of as normal household waste. Instead, it should be disposed of by returning it to the point of sale, or to a municipal recycling collection point.



3 Intended Use

The **VITALITY CHECK** may only be used for the purpose mentioned in this user guide.

ATTENTION!!

The **VITALITY CHECK** is not a medical product and is not intended to diagnose, treat, cure or prevent any disease.

Measure on uninjured bare skin only!

4 System requirements

- USB charging device (can be a wall charger, car charging adapter, USB port of PC. The port must provide at least 500mA of current)
- 2.4 GHz WiFi connection, 54 MBps min.
- Internet connectivity
- iPhone with IOS 12 or newer or Android phone with OS version 8 or newer

5 Download of VITALITY CHECK App

To use the **VITALITY CHECK** the App for IOS or Android must be downloaded onto your smartphone or tablet. Please use the following link for downloading:

Android: <https://play.google.com/store/apps/details?id=net.biozoom.vitalitycheck2020>

IOS: <https://apps.apple.com/de/app/biozoom-vitality-check/id1552854204>

6 Package content

- **VITALITY CHECK** scanner
- Quick Start Guide

7 Product Description

The **VITALITY CHECK** scanner enables the non-invasive measurement of biomarkers in human skin and blood. The technological basis is the MSRRS (**M**ultiple **S**patially **R**esolved **R**eflection **S**pectroscopy) measurement. MSRRS enable the optical detection of non-homogeneously distributed biomarkers in different depth of the tissue, when the user is placing his/her hand on the sensor.

The scanner consists of a lid and the base. To open the scanner, hold the base and turn the lid counterclockwise by a few degrees (**Figure 1**).



Figure 1

The base of the VITALITY CHECK is shown in **(Figure 2)**. The base consists of an On/Off button (1), a connectivity button (3), the USB-C socket (2), the sensor area (8) and several indicators (4, 5, 6).

- On/Off button (1): power on when pressing, hold pressed to force power off.
- USB-C socket (2) to charge the scanner.
- Connectivity button (3): hold pressed to enter initialization mode. More details see chapter 10.1
- The status indicator (4): multicolor LED. Please see chapter 12 for details.
- Progress indicator (5): To indicate the progress of the measurement the progress indicator (6) consists of three symbols and lights up in green while measuring. The three symbols will switch on one after the other until all symbols lit. When the measurement is finished the light will be switched off. More details please see chapter 12.
- The WIFI indicator (6) light up in green and shows the device connectivity status. More details please see chapter 12.
- Groove (7) to align the hand when measuring.
- When measuring the LEDs of the Sensor area (9) will switched on one after the other

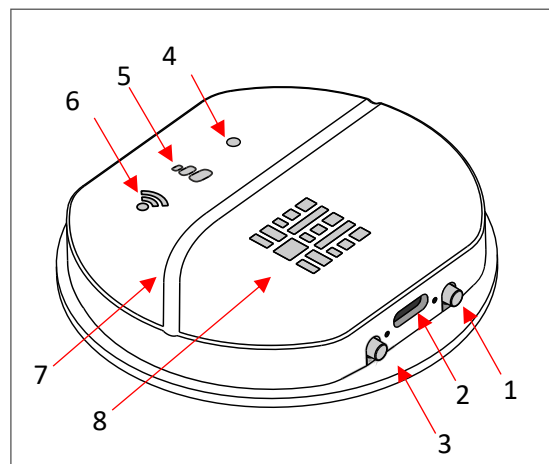

Figure 2

To indicate a present status, the LED of the status indicator (4) shows the following colors:

- Red color: error or problem
- Blue color: In this mode the scanner opens a WIFI network (see chapter 10.1).
- Cyan color: update mode
- White: USB connected, disconnect USB to enter measurement mode

The progress indicator (5) shows the progress. The displayed information has different meaning for every status. See chapter 12 for more information.

WiFi indicator (6) can have the following status:

- Not lit: The scanner is not connected with your smartphone or tablet
- Green color: The scanner is connected with your smartphone or tablet
- Flickering: Scanner is sending data to your smartphone

8 Charging of battery

Most standard chargers equipped with a USB Type-C™ connector are suitable to charge the scanner (see chapter 14 for more details). Once a charger is connected and the scanner is switched on, the battery will be charged, and the big symbol of the progress indicator lights red. If the battery is fully charged the device will stop charging automatically and the red light is switched off.

Attention!!

Please charge the VITALITY CHECK scanner before its first use.

1. Plug the USB C™ cable into the charging port.
2. Connect the cable to a USB charger or USB port.
3. Switch the scanner on. The status indicator lights white. If you do not switch it on the battery cannot be charged.
4. While charging, a red LED is switched on. The LED is switched off when the battery is charged. The LED is located in the biggest symbol of the progress indicator / **Figure 3**
5. After about 3 hours, the device should be disconnected.

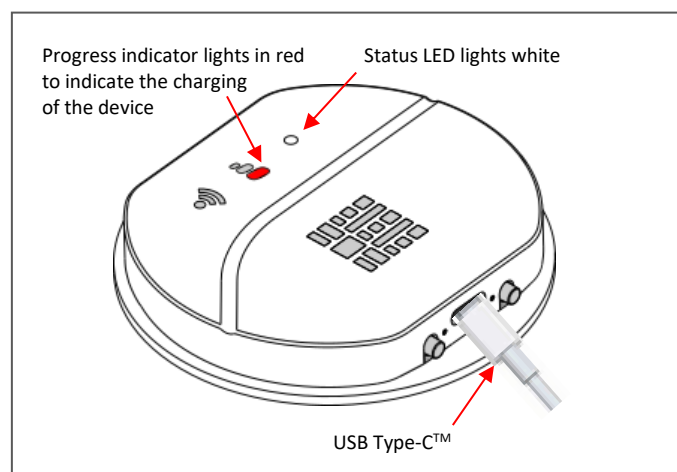

Figure 3

Attention!!

Performing a measurement and charging of the battery at the same time is not possible because charging can influence the quality of the measurement. Please remove the USB cable before starting a measurement.

9 Turning the device ON and OFF

When the VITALITY CHECK is switched off, no LED is lit. If an LED is lit please switch the device off by a long press (ca. 15 sec.) on the ON/OFF button, before performing the following installation steps.

After receiving the scanner, please download the VITALITY CHECK app on your phone/tablet, start the app and follow the instruction. Switch the scanner on when the app requests you to do so. If the status indicator lights orange or the WIFI indicator is lit or flickering green you must press the button “CHANGE MODE” in the app (see setup wizard in the app menu). The app will request you now to press the connectivity button of the scanner until the status indicator lights blue (**Figure 4**). The blue color indicates that the scanner has opened a WIFI hotspot. Now it is possible to connect the scanner to your phone/tablet. The complete procedure how to connect the scanner with your phone/tablet is described in chapter 10.1.

If you switch the scanner ON and you have made measurements already the status indicator will light blue. After opening the app scanner and phone/tablet will be connected automatically because the app has stored the last connection data. You can directly proceed doing a measurement.

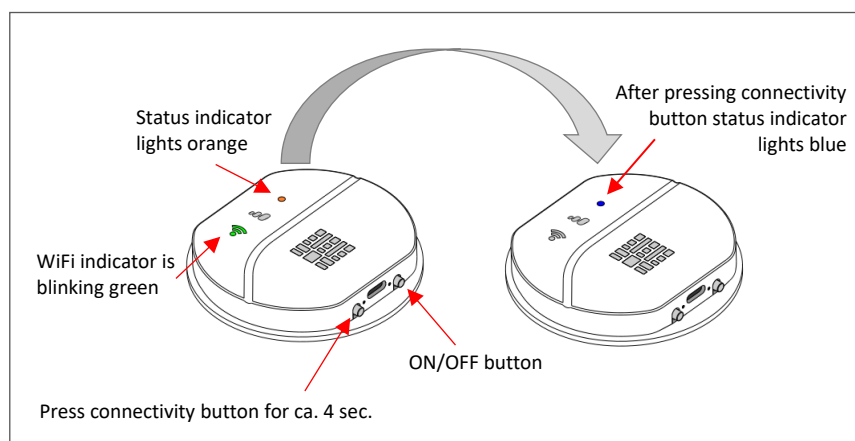

Figure 4

When switching the scanner on while charging the battery or when the battery has been charged before and the scanner is still connected with a USB cable, the status indicator lights white and one symbol of the progress indicator lights red (see **Figure 3**). Under this condition the scanner does not open its Wi-Fi. Please disconnect the USB cable if you like to measure.

If the device does not switch on, the battery may be completely empty. In this case, please charge the battery (chapter 8).

10 Steps for Performing a Measurement

The VITALITY CHECK scanner is a sophisticated device, which takes over 1000 measurement points per single measurement. The calculation of the result needs significant computing power, which cannot be done on the scanner itself. Therefore, the app sends the encrypted data via internet to a central server for calculation of the result. The calculated result is transferred to the app the same way. Typically, the phone/tablet will automatically choose an internet connection. It may use an existing WIFI network or a cellular connection to send the data to the server.

For the communication between scanner and phone/tablet the scanner opens a WIFI hotspot. The phone/tablet must use a WIFI connection to the hotspot to receive the measured data from the scanner. Since a phone/tablet can handle only one WIFI connection at the same time the app may need to change the WIFI connection between connecting to the scanner and connecting to the internet several times. The connection data are stored in the app, so changing from the scanner WIFI to the WIFI used to connect your phone to the internet does not require you to enter passwords or network names. But depending on the version of operating system you will be asked for permission (iPhones and Android 10 and newer phones typically ask for permission, older phones may not).

If you have established the communication between scanner and phone/tablet once, you can conduct measurements without going through the connection procedure again. If you always use the same scanner, you only need to open the app, switch on the scanner, and press the NUTRITION button in the app.

The connection procedure between scanner and phone/tablet is described below. Please read the manual of your phone/tablet if you do not know how to connect it with the internet.

10.1 How to Connect Scanner with Phone/Tablet

The connecting operation is easy and supported by the VITALITY CHECK app. Switch your phone/tablet on. When opening the app, the first time a "Setup wizard" is opened automatically (If you want to run the setup wizard again, you can find it in the main menu). Please follow the instructions step by step until you can select and start a measurement.

The following screen shots concerns only to the connection procedure of the "Setup wizard". Starting a measurement procedure is described in chapter 10.2.

The image of "Step 1" (see below) is displayed on the phone/tablet when the VITALITY CHECK app is opened the first time after downloading. The other steps follow in the pictured order one by one. The app will request you to switch the scanner on (step 7) and to enter the name of the scanners WIFI by scanning the QR-Code of the scanners serial number (see backside of the scanner) or by typing in the serial number manually (step 10 or step 10.1). When connecting a scanner to a phone/tablet the app will download a firmware update automatically if necessary (step 11 – step 14).

Some of the steps are alternative steps and are displayed only when necessary. The connection process is fast and simple and must furthermore be performed only once if you always use the same scanner.

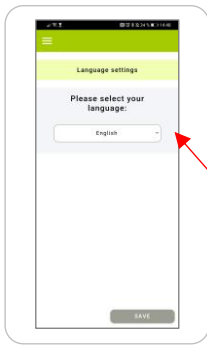

Drop down menu to select language

Step 1
Language selection

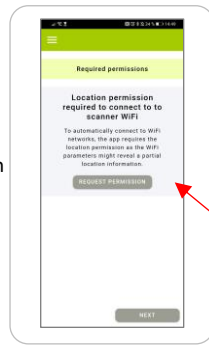

Press "REQUEST PERMISSION"

Step 2
Permission to connect to scanner WIFI

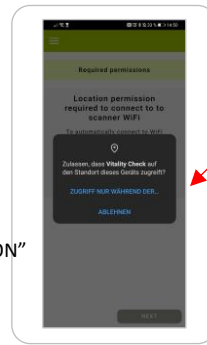

Press "ALLOW"

Step 3
Permission to connect to scanner WIFI

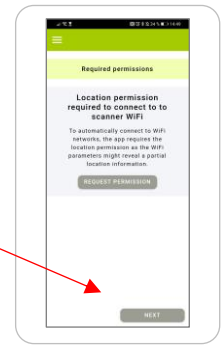

Press "NEXT"

Step 4
Connection permitted

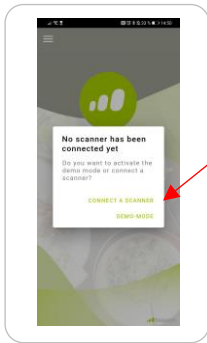

Press "CONNECT & SCANNER"

Step 5
Request to connect the scanner

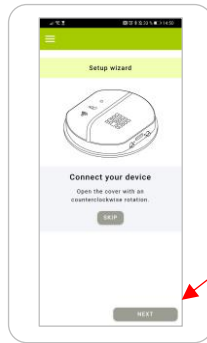

Press "NEXT"

Step 6
Remove the lid/cover from the scanner

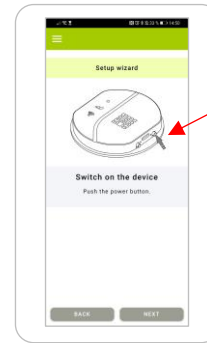

Push this button at your scanner to switch the scanner on

If status indicator does not light blue, press "CHANGE MODE"

Step 7
Switch scanner on

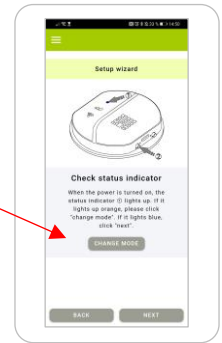

Step 8
Check scanner status

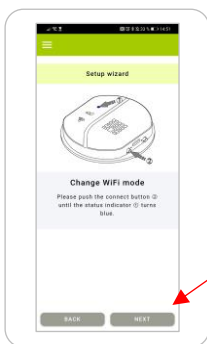

Press "NEXT" if status LED lights blue

Step 8.1
Check scanner status

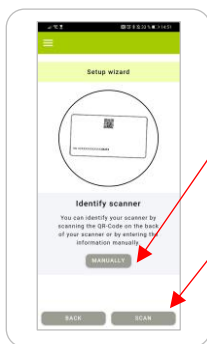

Press "MANUALLY" to type the number

Press "SCAN" for scanning QR-Code

Step 9
Identification enables connection with phone

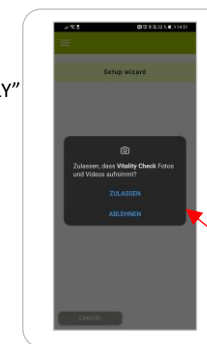

If you have pressed "MANUALLY" use the serial number, its printed on the label of the scanner
If have used QR-Code press "ALLOW"

Step 10
Permission to scan QR-code



Step 10.1
Identification by typing serial number

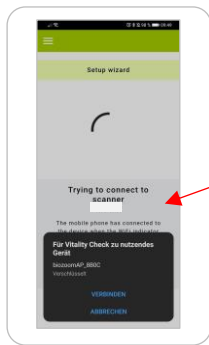

The scanner number will be displayed here

Step 11
Trying to connect to the scanner



Step 12
Check of scanners Firmware



Step 13
Firmware up-to-date

Press "START UPDATE"

Press "NEXT"

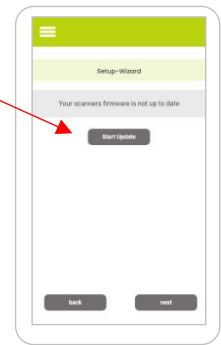

Step 13.1
Firmware is not up to date

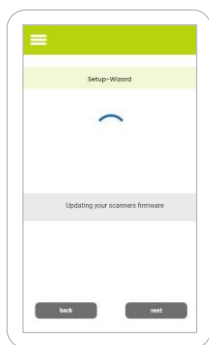

Step 13.2
Firmware will be updated



Step 13.3
Firmware is now up to date, restart scanner

Press "NEXT"



Step 14
Connection scanner with phone successful

Press "NUTRITION" to enable the selection of the antioxidant measurement

Press "LET'S GET STARTED"

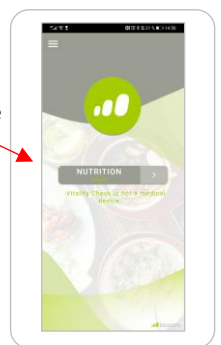

Step 15
Start page for conducting measurements

If you like to connect a different scanner with your phone/tablet after you have connected a first one at an earlier time, please press on the three bars sign in the upper left corner of the VITALITY CHECK app to select and start the "Setup wizard" manually (Figure 5). Follow the instructions to connect the additional scanner now with the phone/tablet. The Setup wizard guides you finally to an app page for selecting and starting a measurement.



Figure 5

Attention!!

Please note that the VITALITY CHECK app stores only the last connection data. Therefore, you must conduct the connection operation again when you have connected a second scanner with your phone/tablet and you like to use now the first scanner once again.

10.2 Performing Measurements

Attention!!

Before you measure the first time please read the general recommendations for a correct measurement listed in chapter 11 “Measurement Basics”. Following the rules of this chapter is essential to receive a correct result.

To carry out the following steps, the VITALITY CHECK app must have been started the first time and the connecting process has been performed successfully and the app is displaying the image of “Step 15” (see above). When pressing the “NUTRITON” button you can select the FULL or the LIGHT version of antioxidants measurement on the following screen.

The FULL measurement is what you typically use. It will measure your nutrition with a precision which is good enough to make changes in your nutrition visible after just a few weeks of a changed diet. The LIGHT version can be used for a quick check when you are in a hurry. It is not recommended for new users, because it cannot detect, if your hand did not contact the sensor in the ideal way during the measurement. Before using the LIGHT mode, please also consider using FULL mode without “Wifi query”, which offers you the precision of the full mode within less time than FULL (see description below). After selecting one of these options the app tries to connect scanner and phone/tablet via the WIFI of the scanner (**Figure 6**).

One important difference between FULL and LIGHT measurement is the number of measurements you need to take. FULL includes four measurements LIGHT only one. Furthermore, in FULL measurement mode the quality of placing the hand on the sensor can also be evaluated. This is important because a non-optimal placement of the hand can influence the result. Both features of the FULL measurement improve the precision of the calculated result (more details see below).

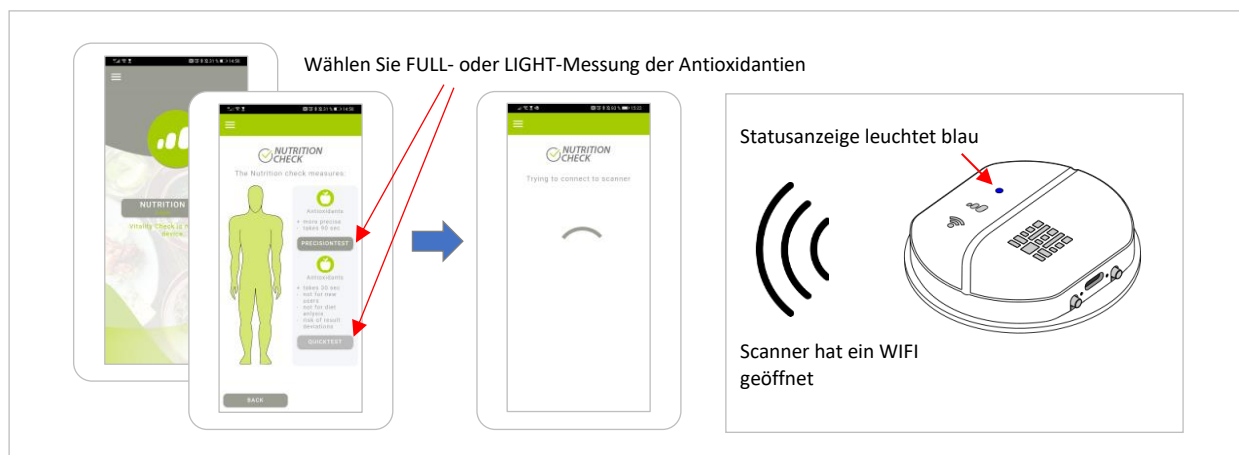

Figure 6

When scanner and phone/tablet are connected the app requests you to place the ball of the thumb on the sensor by aligning the hand with the line of the sensor precisely. The scanner will now check if your hand is present. Every time the scanner checks for your hand it will flash with orange LEDs. The measurement will only start if the hand is placed on the sensor. An automatically timeout will stop the orange blinking after 60 seconds if the user has not placed his hand on the sensor. If the sensor has detected the placement of the hand the measurement starts, and the smallest symbol of the progress indicator stops blinking and lights permanently in green. At that time, the hand should not be moved on the sensor to avoid a miss reading. The progress indicator LEDs on the scanner shows the progress. A green bar on the app indicates the progress too (**Figure 7**).

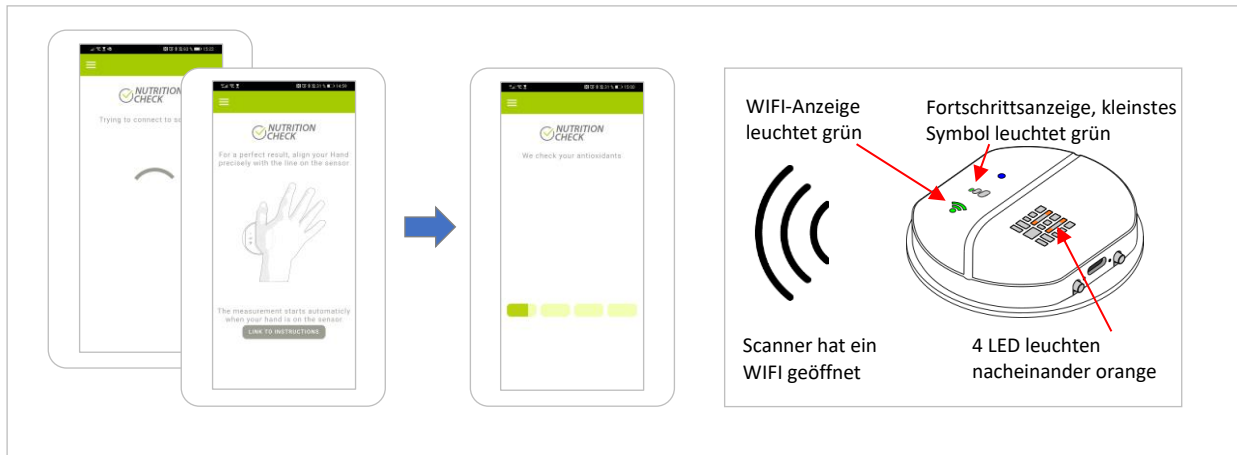

Figure 7

When the measurement is in progress also the second symbol of the progress indicator will light up after some time. The green bar in the app shows, how much of the measurement data has arrived at the phone/tablet. The WIFI indicator flashes once for every packet of data transferred. The measurement is finished when all three symbols of the progress indicator are lighting green and the app request you to take off your hand from sensor. If you do not remove your hand the data will not be send to the server. When taking your hand off, the app tries to connect to the internet. Therefore, the phone/tablet disconnects from the scanner and the WIFI indicator turns off. Only the status indicator still lights in blue (**Figure 8**).

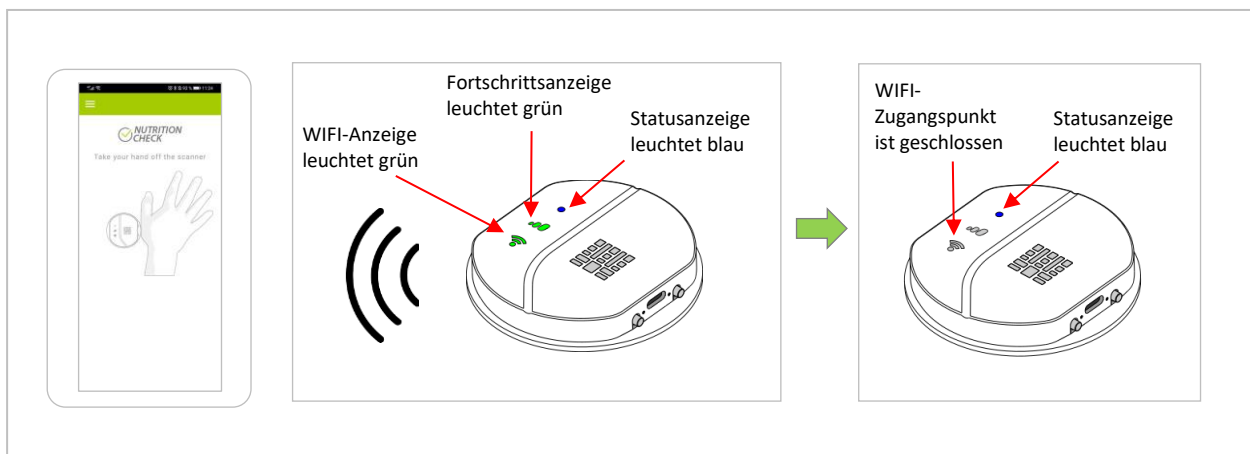

Figure 8

Your phone/tablet will connect to an existing WIFI or alternatively use a cellular connection to the internet. After successful connection, the app informs you that the data has been sent to the server. When the result is available the result is sent to the website of VITALITY CHECK to display it.

When measuring for the first time, you must allow the app to send your measurement result to the website. To avoid this procedure for the next time please press the button "Don't ask again". Then press "Next" to get the result. (**Figure 9**)

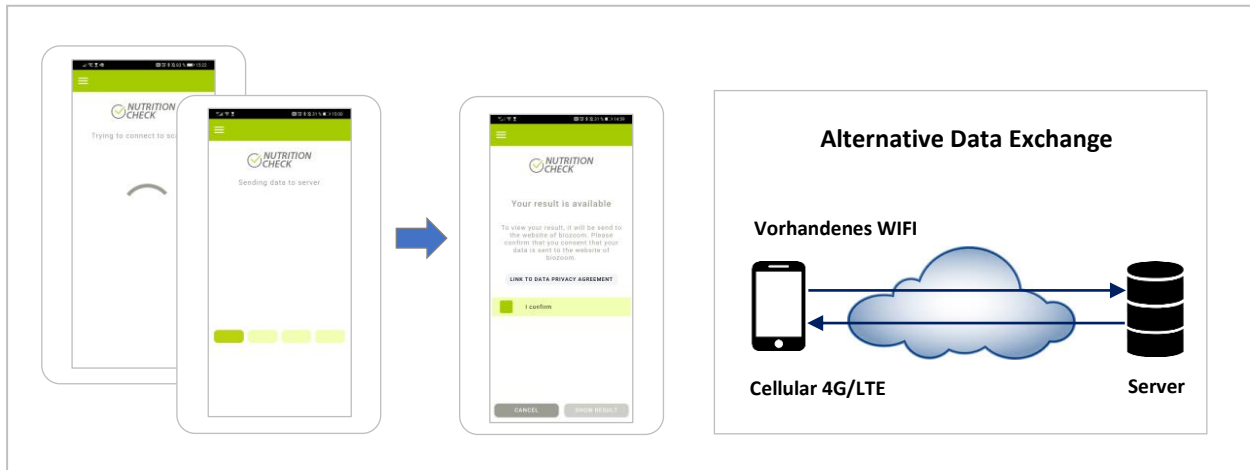

Figure 9

When you have selected the antioxidant FULL measurement (see second image in **Figure 6**) you must make four measurements in succession (**Figure 10**). This greatly reduces the chances of measurement errors, as measurements where the contact between your skin and the scanner was not ideal, can be eliminated. It also means, that you must perform the same procedure four times before you get the final result.

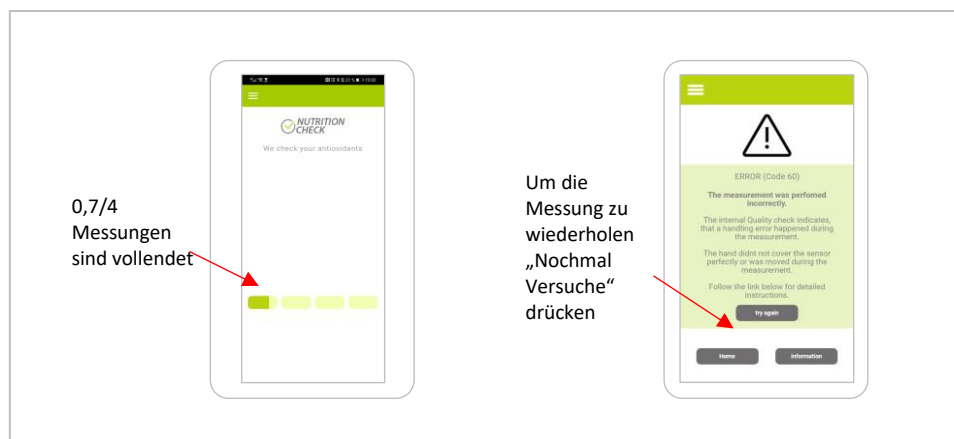

Figure 10

The app offers two modes to do the four measurement steps.

In the standard mode, the data of each individual measurement is evaluated directly after the measurement. This mode is recommended for new users, because it enables the assessment of the hand placement on the scanner for each measurement directly after the measurement is done. In many situations the server will notice if you have not placed the hand on the sensor properly and you will get a message with recommendations. Following these recommendations carefully will give you more precise results and give you a better insight on your nutrition (**Figure 10**). Based on this information the user can improve his handling of the measurement process step by step.

After some time, users typically have enough experience and have learned the perfect use of the scanner. This is the ideal time to change the modes. This can be done in the settings menu under "Wifi query" (Press on the three-bar symbol in the upper left corner of the app and select "Settings" and then select "WIFI query". Then press the button "DEACTIVATE", **Figure 11**).

If you deactivate this option, the app will first complete all four measurements and then send the data to the server for evaluation. This will significantly reduce the time needed for a FULL measurement, because the smartphone does not need to change the Wifi connection from scanner to internet that often. It will also reduce user interaction, as Phones/tablets with IOS operation system or Android 10 and higher always requests the user to confirm that the change of Wifi connection is tolerated by the user.

The drawback of this configuration is that the user is not informed right away, if the placement of the hand was incorrect and incorrect single measurements cannot be repeated in this mode. If the placement of the hand was incorrect for only one of the four measurements the app requests the user to repeat all four measurements. Of course, you can activate the “WIFI query” again.

It is recommended that the user starts with the standard configuration and select the alternative only after he has learnt the optimal handling.



Figure 11

11 Measurement basics

The VITALITY CHECK is a sensitive sensor that is able to detect certain nutrient substances in the human skin. It is strongly recommended to read and follow the tips below to get as precise and reliable results as possible.

Preparation before starting a measurement

- Rest your body before starting measurement.
If you do physical exercise right before the measurement, you can often see an effect on your antioxidant measurement as well as on heart rate variability that does not reflect your general level. If you want the maximum measurement precision, allow your body to rest 20 minutes between exercise and measurement.
- Measure at the same time each day to get consistent results. The antioxidant level may change during the day.
During sleep your body relaxes and recovers. You can see that in the antioxidant value as well. Most people have a higher value in the morning and during the activity and stress of the day the value drops and is lowest in the evening. With some people, it goes up right after they had healthy food and a lunchbreak. The changes between morning and evening typically have a magnitude of 0.1 to 0.5. You can also find differences between Monday and Friday because of workload or job-related stress and the recovering at the weekend.
- Measure with dry skin only. If you washed your hands with soap and dried them up thoroughly, there is still some water that remains on the skin for a while. It will have a small effect on the measurement, so it is better to wait 30 minutes after washing hands to get the most precise results.
- Measure on unhurt, healthy, untreated, bare, and dry skin only to get consistent results. If you suffer from any skin diseases, the sensor will probably not be able to measure correctly, because it is calibrated for healthy skin only.
Skin treatments of any kind, e.g., skin care products, cosmetics, sun protection, tattoos, will influence the measurement. Hair will also have an influence. Therefore, we recommend measuring on the base of your right hand's thumb.

Performing measurements

- Measure in sitting position with the scanner lying on the table (**Figure 12**)
- Rest your elbow on the table for controlling the pressure when placing the hand on the sensor. Apply no additional force, the weight of your hand/arm is enough.
You can get to the ideal contact pressure by letting the hand rest on the sensor with its own weight. Do not use the muscles of the arm to lift the hand or to press it onto the sensor. The ideal contact pressure is approximately equivalent to 800g of weight which is about two pounds. The reason for this is, that your blood contains antioxidants. If you press against the sensor too hard, you push some blood out of the skin and change the effective antioxidant level. The sensor has a function that compensates the effect of the contact force. So, you do not need to worry to get a perfect contact pressure. But if your contact pressure is ideal you still get a little bit better result. Pushing blood out of the skin will make the measurement of heart rate variability completely (HRV) impossible (relevant only for models which measure HRV).



Seating position - sensor on the table



Rest the elbow on the table - no additional force when measuring

Figure 12

- Lay your right hand softly on the sensor by using the groove to align the hand precisely. Measuring always the exact same spot helps you to see the effect of a change in nutrition and lifestyle correctly, as the concentration of nutrient substances varies a little bit between different surface areas of your hand (**Figure 14, Figure 14**).
- Do not move your hand or shift weight during measurement.
It is important to hold your hand still during the measurement. The scanner does a set of different measurements and compares the results. If the hand moves between the measurements or the contact to the scanner varies the comparison works less well. The measurement starts automatically as soon as it detects your skin. To make sure not to move your hand after the measurement has started, avoid correcting the position of the hand on the scanner after the skin touches the scanner.



Use the groove to align the hand precisely



Do not move your hand while measuring

Figure 13

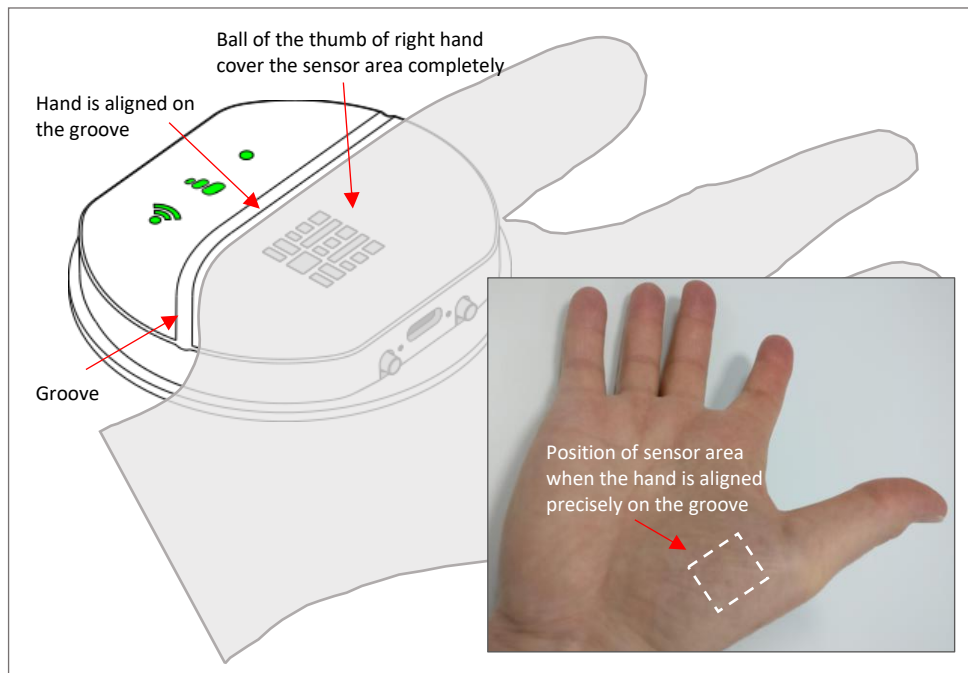

Figure 14

- Avoid bright light on your hand while measuring (sunlight, bright artificial light). Cover the hand if necessary.

Bright light is able to get through your hand. You can try that by switching on the LED flashlight of your smartphone and putting a finger on top of it. You can see that especially red light can get all the way through your finger. Sunlight is even stronger and can get through all of your hand. That is why the biozoom sensor does refuse to measure in direct sunlight. If you want the maximum precision, you can help the sensor by making sure no bright light hits the back of your hand while measuring. Normal ceiling light typically is no problem.

General aspects influencing the level of measured results

The scanner measures the presence of certain nutrition substances in your tissue. The substances measured are carotenoids. These are substances which naturally occur in fruit and vegetable. They are an excellent marker for the quality of your nutrition and your antioxidant level.

Everything you eat and drink, including normal food, drinks and nutritional supplements influence your results. Your results are also influenced, by how much nutritional supplements are consumed by your body. Your body requires these substances to defend itself against free radicals which can be generated in many ways. Examples are: smoking, radiation such as strong sunlight, stress and strong physical exercise. Even though a complete list of all influences would exceed the scope of this document, a few important examples have listed her:

- Note that prolonged exposure to sunlight or the use of sunbed may temporarily lower your antioxidant value.
- Influence of wearing gloves.

If you wear gloves at work, be aware that there sometimes is a significant effect on the antioxidant concentration. You will get better results if you always measure before work.

- Note that illness may lower your antioxidant value.
If you have a cold or some other illness it means stress for your body. Be aware that usually your antioxidant values go down in such a case because your body uses up some of the nutrient substances the scanner measures. Wait until you have recovered before you compare two results.
- Reasonable physical exercise supports your antioxidant level, but strong physical exercise may temporarily lower your antioxidant value.
- Note that smoking result in a constant lower level of antioxidant value compared to non-smoking.
- Note that excessive consumption of alcohol may lower the antioxidant value temporarily.
- Be aware that there are several other effects which can influence the nutrition substances measured by the scanner.

12 Troubleshooting

Below you find a table summarizing all functions and status indication relevant for the use of the scanner. If you face an unexpected behavior of the scanner this table helps you to understand it. If further actions are necessary, this table inform about this.

For unexpected events not listed in the table please carry out the following steps:

1. Switch the scanner off by holding the ON/OFF button pressed for 15 seconds.
2. Restart the app.
3. Switch on again by pressing the ON/OFF button for 1 second.

Since the scanner will indicate its status by lighting of a specific color or a combination of colors of different indicators the table below has a ranking based on colors.

- 1 On/Off button
- 2 USB-C socket
- 3 Connectivity button
- 4 Status indicator
- 5 Progress indicator
- 6 WiFi indicator
- 7 Groove
- 8 Sensor area

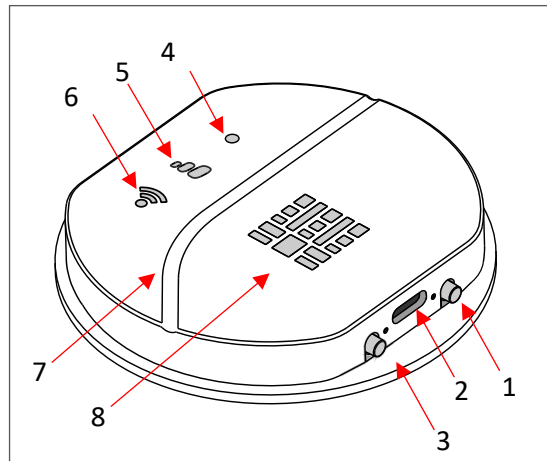

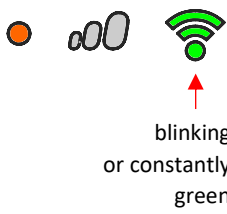









Figure 15

No.	Indicator	Condition	Situation
1		Scanner off	Press button (1) shortly to switch the scanner on. Never press button (3) in parallel for switching the scanner on because scanner will change to the update mode. For <u>switching</u> the scanner <u>off</u> press button (1) ca. 15 seconds
2		Scanner is switched on. Charging battery via USB, or USB cable connected to computer	Remove USB-C cable to make a measurement. Scanner will be switched off after removal of USB-C cable.
3		Scanner's firmware is prior to 2021 Scanner is switched on, status indicator lights orange and WiFi indicator lights green or is blinking green	Follow the instructions of the setup wizard of the app when connecting the scanner to the smartphone/tablet. (see step 8 in chapter 10.1). When you start the app for the first time, you will automatically be in setup mode. If you want to connect a new scanner to your smartphone/tablet, you must start the setup wizard yourself. To do this, press the three lines in the top left of the app and select it from the pull-down menu. Then follow the instructions of the app again.
4		Scanner's WIFI is activated	Connection with phone/tablet is possible now. If a connection has already been established with this phone/tablet before, a new connection is automatically established when another measurement is conducted.

5	 <p>blinking</p>	Phone/tablet is connected with the scanner. Scanner requests you to place the hand on the sensor area	Scanner is requesting to place the ball of the thumb on the sensor. The first symbol of the progress indicator is blinking and LEDs on the sensor area are flashing orange.
6	 <p>flickering</p>	Scanner is measuring	You have placed your hand on the sensor area after the request of the scanner and the sensor has detected the placement. Measurement has been started. The number of green symbols indicate the progress. Any time a data package is sent to the phone/tablet the WiFi indicator will flicker. Do not move your hand now.
7	 <p>flickering</p>	Scanner is measuring	You have placed your hand on the sensor area after the request of the scanner and the sensor has detected the placement. Measurement is running. The numbers of the green symbols indicate the progress. Any time a data package is sent to the phone/tablet the WIFI indicator will flickering. Do not move your hand now.
8		Scanner has finished the measurement	The measurement has been finished.
9	 <p>blinking</p>	Scanner has finished the measurement. Scanner requests you to take your hand off the sensor	The measurement has been finished and you have still placed your hand on the sensor. By blinking of the smallest symbol, the scanner requests you to take off your hand. If you do not do it data will not be send to the server for calculation. Please take off your hand from the scanner now.
10	 <p>each symbol is repeatedly switched on one after the other.</p>	Firmware update mode	Update mode has been started.

13 Maintenance and Cleaning

The VITALITY CHECK needs no regular maintenance and has no user-maintainable parts.

To ensure consistent measurement quality, a regular cleaning is recommended. Please use a slightly damp, soft cleaning cloth.

Never use paint thinner, benzene, alcohol, disinfectants or sanitizers, or other strong cleaning agents when cleaning the VITALITY CHECK, as these could damage the case and the optical surface of the sensor.

If needed the sensor surface can be disinfected by wiping it with a cloth with 70% isopropanol.

14 Technical Specification

Parameter	Specification
Function	Optical scanner to measure optical properties of human tissue on the ball of the thumb (thenar) Use only as specified in this manual
Model	MSRRS SCN05
Electrical parameter	5V, 500mA max.
Lithium-Ion battery	Replace only with original battery from Biozoom Charging battery only in ambient temperature of +5°C ... +40°C
Operating temperature range	15° C ... 35° C
WiFi	2.4GHz, 54 MBps min., up to 3m range
Buttons	On / Off button (2) Connectivity button (4)
Port	USB Type-C™



15 Certifications



Contains:

FCC ID: 2AC7Z-ESPWROOM-32E
IC: 21098-ESPWROOM-32E
MIC 217-204070
NCC AK21Y10020T0

VITALITY CHECK

Product name: BIOZOOM
Brand name: BIOZOOM
Model No.: MSRRS SCN05
Battery: 3.7Vdc. 500mAh lithium ion
Manufacturer: biozoom services GmbH

CAUTION

RISK OF EXPLOSION IF BATTERY REPLACED BY AN
INCORRECT TYPE.

DISPOSE OF USED BATTERIES ACCORDING TO THE

FCC statement This device complies with part 15 of the FCC Rules. Operation is subject to the following two conditions: (1) This device may not cause harmful interference, and (2) this device must accept any interference received, including interference that may cause undesired operation.

Important Note: To comply with the FCC RF exposure compliance requirements, no change to the antenna or the device is permitted. Any change to the antenna or the device could result in the device exceeding the RF exposure requirements and void user's authority to operate the device.

manufactured and distributed by:

Biozoom Services GmbH
Ziegelstraße 17
D-34121 Kassel
Germany